

AC adapter: 100 to 240 Volts AC,
50/60 Hz, Output 5V DC 1.2A

12535

AA x3 | Batteries not included.
Requires 3 AA batteries.

Star Theater Pro[®]

optical star projection system



Instruction Manual

TABLE OF CONTENTS

Important Safety Instructions	2
Star Theater Pro Components	4
How to Power the Projector	5
Basic Operation	5
How to Change the Image Disc	6
How to Adjust the Projection Angle	6
How to Adjust the Focus	7
Additional Features	7
Tables	8

IMPORTANT SAFETY INSTRUCTIONS

WARNING:

TO REDUCE THE RISK OF FIRE OR ELECTRIC SHOCK, DO NOT EXPOSE THIS PRODUCT TO RAIN OR MOISTURE.

CAUTION:

TO REDUCE THE RISK OF ELECTRIC SHOCK, DO NOT REMOVE COVER OR BACK. NO USER-SERVICEABLE PARTS INSIDE. REFER SERVICING TO QUALIFIED SERVICE PERSONNEL.



 The lightning flash with arrowhead symbol, within an equilateral triangle, is intended to alert the user to the presence of uninsulated "dangerous voltage" within the product's enclosure that may be of sufficient magnitude to constitute a risk of electric shock to persons.

 The exclamation point within an equilateral triangle is intended to alert the user to the presence of important operating and maintenance (servicing) instructions in the literature accompanying the appliance.

1. Read and follow these instructions.
2. Keep these instructions and heed all warnings.
3. Do not use this apparatus near water.
4. Clean only with dry cloth.
5. Do not block any ventilation openings. Install in accordance with the manufacturer's instructions.
6. Do not install near any heat sources such as radiators, heat registers, stoves, or other apparatus (including amplifiers) that produce heat.
7. Protect the power cord from being walked on or pinched particularly at plugs, convenience receptacles, and the point where they exit from the apparatus.
8. Only use attachments/accessories specified by the manufacturer.
9. Unplug this apparatus during lightning storms or when unused for long periods of time.
10. Refer all servicing to qualified personnel. Servicing or replacement is required when the apparatus has been damaged in any way.

11. Unplug the product from the wall outlet and refer servicing to Uncle Milton Industries under the following conditions.

- A. The power-supply cord or plug is damaged;
- B. Liquid has been spilled, or objects have fallen into the apparatus;
- C. The apparatus has been exposed to rain or water;
- D. The apparatus does not operate normally by following the operating instructions. (Adjust only those controls that are covered by the operating instructions, as an improper adjustment of other controls may result in damage and will often require extensive work by a qualified technician to restore the apparatus to its normal operation);
- E. The apparatus has been dropped or damaged in any way;
- F. The apparatus exhibits a distinct change in performance.

CARE

- When not in use, cover the lens with the lens cap.
- Do not touch the lens. Gently wipe off dust using a soft cloth or lens paper. Never use facial tissue to clean lens.
- Occasionally dust the unit with a soft cloth. For stubborn stains, use a soft cloth dampened with a weak solution of mild detergent and water. Dry the unit immediately afterwards with a clean cloth.
- Do not use abrasive cloths, thinners, alcohol, or other chemical solvents, because they may damage the finish or remove the lettering.

For U.S. models

FCC Information for User

This device complies with part 15 of the FCC Rules. Operation is subject to the following two conditions:

- (1) This device may not cause harmful interference, and
- (2) This device must accept any interference received, including interference that may cause undesired operation.

CAUTION:

Any user changes or modifications not expressly approved by the manufacturer could void the user's authority to operate the equipment and will void the warranty.

NOTE:

This equipment has been tested and found to comply with the limits for a Class B digital device, pursuant to Part 15 of the FCC Rules. These limits are designed to provide reasonable protection against harmful interference in a residential installation.

This equipment generates, uses, and can radiate radio frequency energy and, if not installed and used in accordance with the instructions, may cause harmful interference to radio communications. However, there is no guarantee that interference will not occur in a particular installation. If this equipment does cause harmful interference to radio or television reception, which can be determined by turning the equipment off and on, the user is encouraged to try to correct the interference by one or more of the following measures:

- Reorient or relocate the receiving antenna.
- Increase the separation between the equipment and receiver.
- Connect the equipment to an outlet on a circuit different from that to which the receiver is connected.
- Consult the manufacturer or an experienced radio/TV technician for help.

STAR THEATER PRO COMPONENTS

- 1) Lens cap
- 2) Focus dial
- 3) Projector sphere
- 4) AC adapter jack
- 5) Image disc tray
- 6) ON/OFF button
- 7) Timer button (30/60 minutes)
- 8) Move button (image rotation)
- 9) Open button
- 10) Upper base
- 11) Lower base
- 12) Battery power cord



ACCESSORIES:

- Image discs
 - Starfield disc
 - Earth / Moon / Sun disc
- AC adapter
- Planetarium music CD
- Instruction manual

BATTERY SAFETY INFORMATION

- Non-rechargeable batteries are not to be recharged.
- Rechargeable batteries are only to be charged under adult supervision.
- Rechargeable batteries are to be removed from the toy before being charged.
- Different types of batteries or new and used batteries are not to be mixed.
- Batteries are to be inserted with the correct polarity.
- Exhausted batteries are to be removed from the toy.
- The supply terminals are not to be short-circuited.

HOW TO POWER THE PROJECTOR

The planetarium is powered by batteries (not included) or the included AC adapter.

BATTERY POWERED OPERATION

The projector requires three (3) "AA" alkaline batteries. Do not use rechargeable batteries.

- Remove battery compartment cover located underneath the base (Figure 1).
- Insert three (3) "AA" alkaline batteries. **Make sure the "+" and "-" ends are inserted correctly, as indicated in battery compartment.**
- Replace battery compartment cover.
- Insert battery power cord plug into power jack (Figure 2).

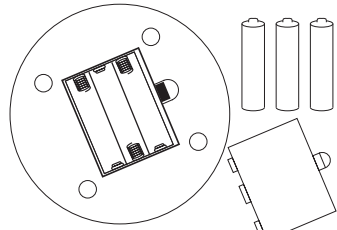

Figure 1

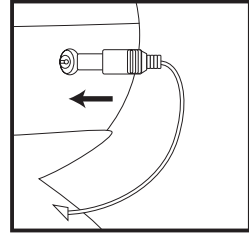

Figure 2

AC POWERED OPERATION

- Insert AC adapter plug into power jack (Figure 3).
- Plug AC adapter into an electrical outlet.

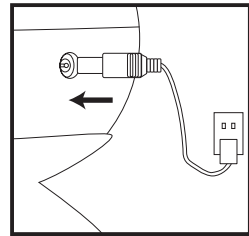

Figure 3

BASIC OPERATION

1. Place the planetarium on a stable surface such as a tabletop. Optimal projection distance is 6.5 to 7.5 ft (2 to 2.3m) (Figure 4).
2. Make sure that the projector is powered for operation by either batteries or AC adapter (see above).
3. Open image disc tray by pressing the open button (Figure 5). Insert an image disc, making sure disc is right-side-up, with the "© UMI" inscription centered between the two front tabs. Close image disc tray manually until it clicks (Figure 6).
4. Remove lens cap (Figure 7).
5. Press ON/OFF button so that the LED indicator glows red (Figure 8). Darken the room to project the night sky onto a flat, white surface.
6. You can listen to planetarium background music by playing the included CD in a CD player.

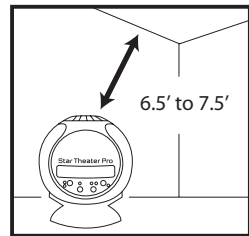

Figure 4

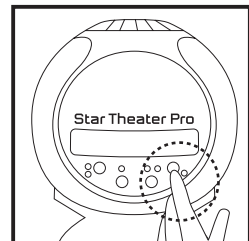

Figure 5

HOW TO CHANGE THE IMAGE DISC

1. Shut off projector by pressing ON/OFF button so that the LED indicator goes off (Figure 8).
2. Open image disc tray by pressing open button, and remove the image disc (Figure 5).
3. Insert another image disc, making sure disc is right-side-up, with the “**UMI**” inscription centered between the two front tabs. Close image disc tray manually until it clicks (Figure 6).
4. Turn on projector by pressing ON/OFF button so that the LED indicator glows red (Figure 8).

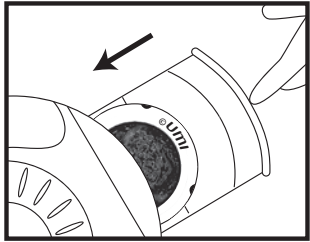

Figure 6

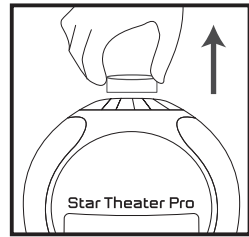

Figure 7

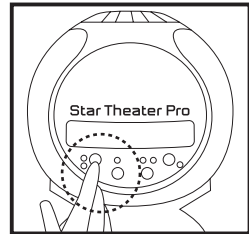
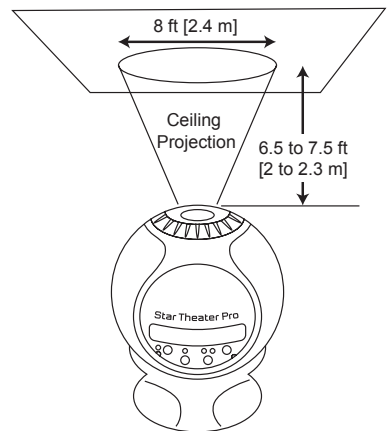
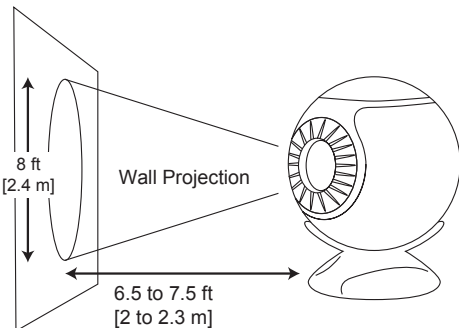

Figure 8

HOW TO ADJUST THE PROJECTION ANGLE

- Rotate projection sphere in its base for wall or ceiling projection.
- Projection surface should be flat, smooth and white or light-colored. The brightness and contrast of the projected image depend on the projection surface and on the darkness of the room.
- Optimal projection distance is 6.5 to 7.5 ft (2 to 2.3m) (Figure 4).



HOW TO ADJUST THE FOCUS

- Turn focus dial until the projected image is sharp (Figure 9). The edges of the projected image may appear slightly out of focus or stretched compared to the center of the image. This is due to the nature of the lens and flatness of the projection surface, and is not a malfunction.

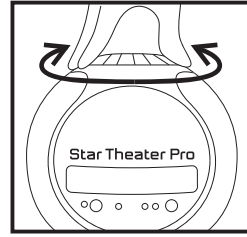

Figure 9

ADDITIONAL FEATURES

Auto-Off Timer

- Press timer button once for a 30-minute projection duration. The LED with "30" marked above it will glow green. The projector will automatically shut off after 30 minutes (Figure 10).
- Press timer button again for a 60-minute projection duration. The LED with "60" marked above it will glow green. The projector will automatically shut off after 60 minutes (Figure 10).
- Press timer button a third time to cancel auto-off function (Figure 10).
- If timer is not set for 30 or 60 minutes, the projector will shut off automatically after 2 hours.

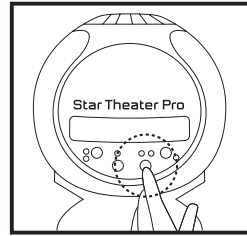

Figure 10

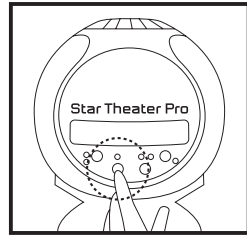

Figure 11

Auto-Rotation

- Press move button to start auto-rotate function. The LED above the move button will glow green. The projected image will continuously rotate, one full revolution per 10-minute interval (Figure 11).
- Press move button again to shut off auto-rotate function.

Planet Information Table

NAME	DISTANCE FROM SUN (millions of mi/km)	ORBITAL PERIOD (in Earth years)	ROTATION PERIOD (hours in day)	SIZE RELATIVE TO EARTH	MASS RELATIVE TO EARTH	MOONS**	RINGS
MERCURY	36 / 58	0.2	1416	0.39 X	0.06 X	0	No
VENUS	67 / 108	0.6	5833	0.95 X	0.8 X	0	No
EARTH	93 / 150	1.0	24	1 X	1 X	1	No
MARS	142 / 228	1.9	25	0.53 X	0.1 X	2	No
CERES*	260 / 420	4.6	9	0.08 X	0.0002 X	0	No
JUPITER	484 / 778	11.9	10	11.2 X	318 X	63	Yes
SATURN	884 / 1423	29.5	10	9.4 X	95 X	60	Yes
URANUS	1783 / 2869	84	17	4.0 X	15 X	27	Yes
NEPTUNE	2792 / 4492	164.8	16	3.8 X	17 X	13	Yes
PLUTO*	4650 / 7500	248	153	0.2 X	0.002 X	3	No
ERIS*	9114 / 14,700	557	7	0.2 X	0.003 X	1	No

*Dwarf planet

**Known as of March 2009

Annual Meteor Showers

Shower	Date	Hourly	Parent comet
Quadrantids	January 3	40	Asteroid 2003 EH1
Lyrids	April 22	15	Comet Thatcher
Eta Aquarids	May 5	20	Comet Halley
Delta Aquarids	July 28	20	(Unknown)
Perseids	August 12	50	Comet Swift-Tuttle
Orionids	October 22	25	Comet Halley
Taurids	November 3	15	Comet Encke
Leonids	November 17	15	Comet Temple-Tuttle
Geminids	December 14	50	Asteroid 3200 Phaethon
Ursids	December 23	20	Comet Tuttle

Dates can vary slightly. Hourly rate represents the number of meteors you might see under a dark sky when the radiant is near the zenith. Expect to see perhaps half as many more if the shower is strong.

Source: *Skywatching* by David H. Levy (Time-Life Books, 1994-98).

KEEP THESE INSTRUCTIONS FOR FUTURE REFERENCE — DO NOT DISCARD

Questions? Comments? Please contact us. We can help!

1-888-742-2484 or go to www.unclemilton.com

Farm Fresh®

© 2009 UMI. All rights reserved.

Star Theater and Farm Fresh are registered trademarks of Uncle Milton Industries, Inc.

Westlake Village, CA 91362

Printed in China

Product and colors may vary